

➤ High on **intelligence**  
big on reliability



## **Sx2000** | AC Drive

Single-Phase 230V (0.75 ~ 3.7kW)

Three-Phase 230V (0.75 ~ 18.5kW)

Three-Phase 415V (0.75 ~ 90kW)

## Two decades of application knowledge

For over two decades, various industry sectors have been reaping the benefits of L&T's cost-effective, performance-oriented AC Drive solutions. L&T's grasp of the specific needs of each industry enables it to offer application-specific solutions for various industries – such as processing, textile, plastic, ceramic, pharmaceutical, elevator, oil & gas, power, cement and material-handling.



# Sx2000

## AC Drive

### › The new **reliability** edge

The Sx2000 adds a new dimension to L&T's AC drive solutions. Built to L&T's stringent quality standards, the Sx2000 is tested and certified to meet global benchmarks, thus giving you the assurance of total reliability.

The Sx2000 is built to deliver powerful performance. It handles loads up to 75 kW (HD) / 90 kW (ND) – making it perfect for compressors, conveyors, machine tools, elevators, textiles, fans, pumps, plastic extruders, wire drawings, etc.



Parameters can be copied/loaded from the drive to the smart copier and vice versa – simply with the keypad. It produces a starting torque of 200% at 0.5 Hz, which provides better control at low-speed. Its compact size enables panel-size reduction, hence helps in space-efficient design. It has safety features like Safe Torque Off (STO) with redundant input circuit which meet EN 61508 SIL 2 standards.



## ➤ **Backed** by engineering knowledge across seven decades

A knowledge-based company, L&T brings you the benefits of over 75 years of engineering experience and expertise, and the richness of its collaborations with technology leaders across the globe.

For 50 years, L&T's low-tension switchgear – India's widest range – has been the preferred option of top industrial houses countrywide.



## ➤ Meeting your needs, solving your problems

We believe in addressing your needs and not just selling a product. That's why a dedicated Solutions Team first focuses on understanding your application. Then helps you select the drive that best meets your needs. Our advice on installation, maintenance and replacement will ensure that your machines function at peak productivity. From engineer to repair technician, our people have the knowledge and skill-sets to deliver total peace of mind.







## ➤ **Tested. Certified. Reliable.**

L&T is one of the few switchgear manufacturers in India with a dedicated, NABL-certified testing facility. Our products are tested for conformity to standards that exceed minimum requirements, giving you the assurance of high-quality performance. Our focus on continuous improvement ensures that our standards are on par with the best in the world. Repeat orders endorse the value that we deliver.

The reliability of the Sx2000 is ensured by international test certification – UL, CE and RoHS.

## ➤ **After-sales service** aimed at maximum uptime

A malfunction of the drive can bring an entire assembly line or process to a halt. To ensure maximum uptime for you, our Rapid Response service team is available to analyze the situation and help you set the problem right. We have set up strategic service centres across the country to provide temporary replacement drives or ready spares to ensure that your business keeps running smoothly.

**Rapid Response Service Team**





## ➤ **Training your people** to enhance your operations

At our countrywide Switchgear Training Centres, we can train your operators, electricians and supervisors to increase their effectiveness in the operation, maintenance and trouble-shooting of your drives. We can also conduct in-plant training and workshops at your premises to improve both power management and equipment maintenance skills. This gives you total operational excellence, minimising downtime.

L&T's engineers and channel partners also upgrade their skills through seminars, workshops, training sessions and white papers on electrical practices.

## ➤ **Features** that ensure performance

### Powerful performance



- Sensorless control functions
- Starting torque (200%/0.5Hz)

### Safety functions



- Built-in Safe Torque Off (STO)
- Redundant input circuit

### User-friendly



- Various field networks

### Standard compliance



- International standards

### Space-efficient design



- Side-by-side installation
- Decreased dimensions



# Sx2000

Smart. Space-efficient. Safer.

Built to deliver powerful performance, its smart features, compact size and safety features increase efficiency.



## Specialized Features

Sx2000 improves user convenience with a smart copier.

### Functions without power input

The drive does not need to be powered when using the smart copier.

### LED lamp feedback

The run LED flickers during normal operation. The error LED flickers when events such as communication errors occur.

### Read/Write function of parameters

Parameters can be copied/loaded from the drive to the smart copier and vice versa, simply with the keypad.

### Simple installation

I/O parameter and main firmware saved in the smart copier can be downloaded to both the drive I/O and the control part. Firmware can be downloaded from a PC by using a USB cable.

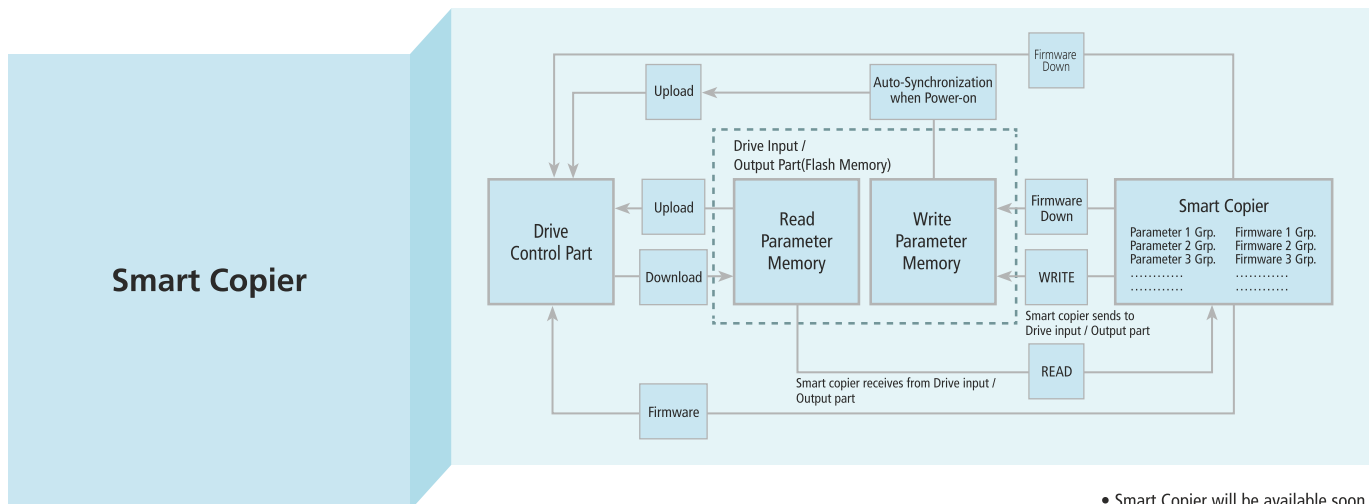
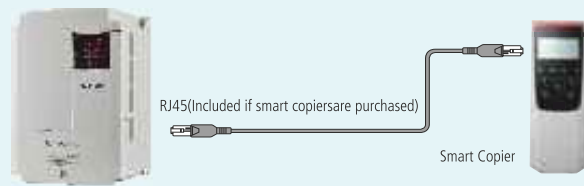

• Smart Copier will be available soon.

**Peer 2 Peer function embedded**

I/O can be shared among master and slave drives. (RS485 wiring required).

**Main capacitor lifecycle estimation**

Estimated through monitoring the change in the capacitance value (Fig.1).

**Fan lifecycle estimation**

Warning signal is displayed when fan is operated over a certain amount of hours (Fig.2).

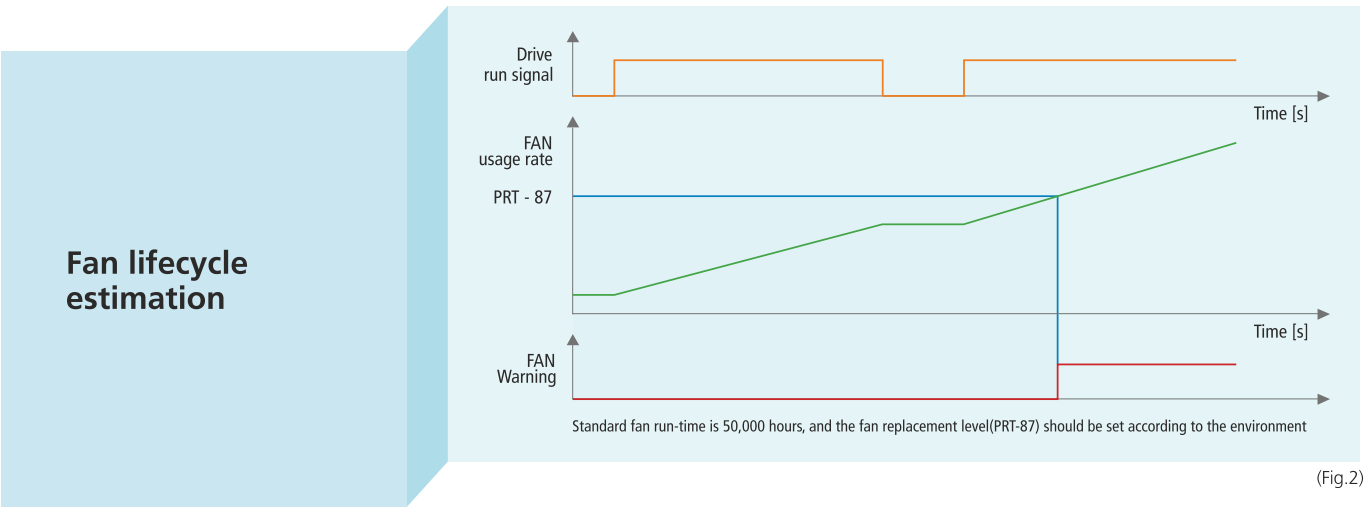
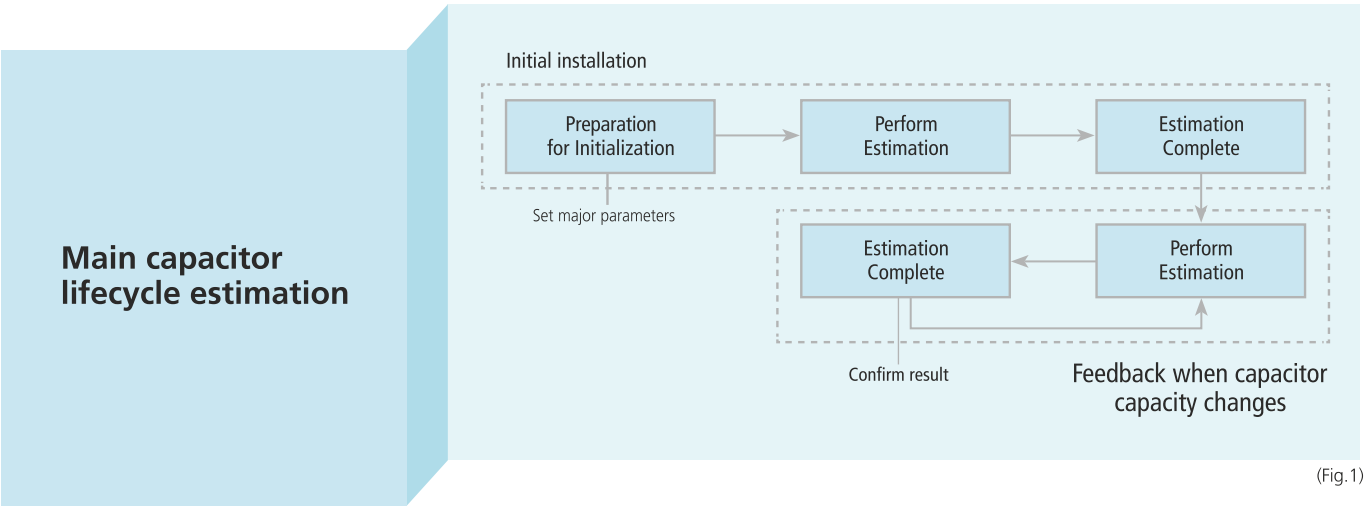

## Powerful Performance

Sx2000 is a drive with enhanced sensorless control.

### Powerful sensorless control

Starting torque of 200%/0.5Hz is produced and provides robust power in the low speed region. The motor auto-tuning function is optimised to maximise motor performance.

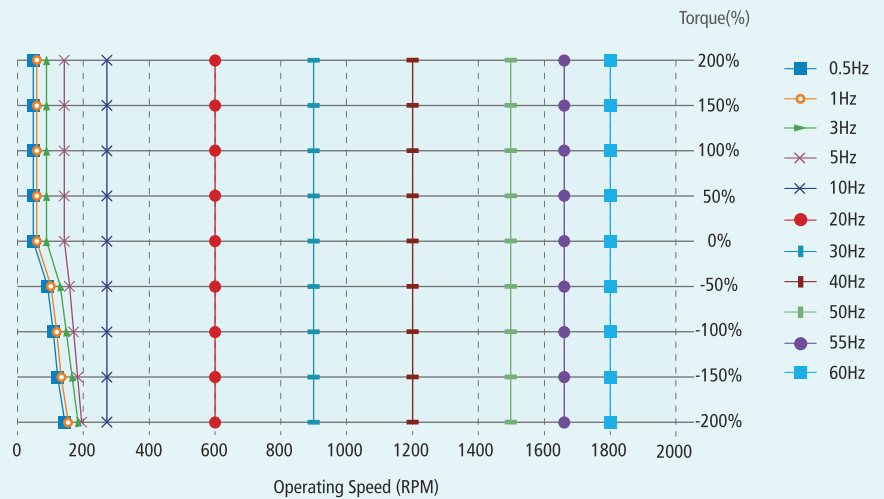

### Flying-start function

Drive capable of reliable and smooth re-starts even for bi-directional rotating loads

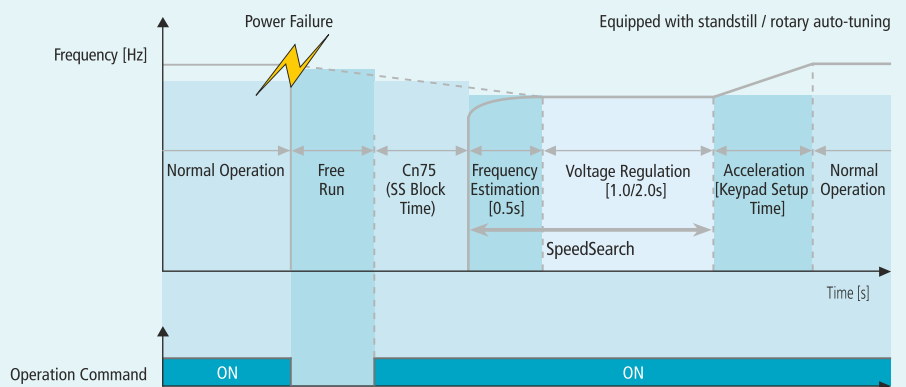

### Space Efficient Design

The Sx2000 increases the efficiency of the control panel.

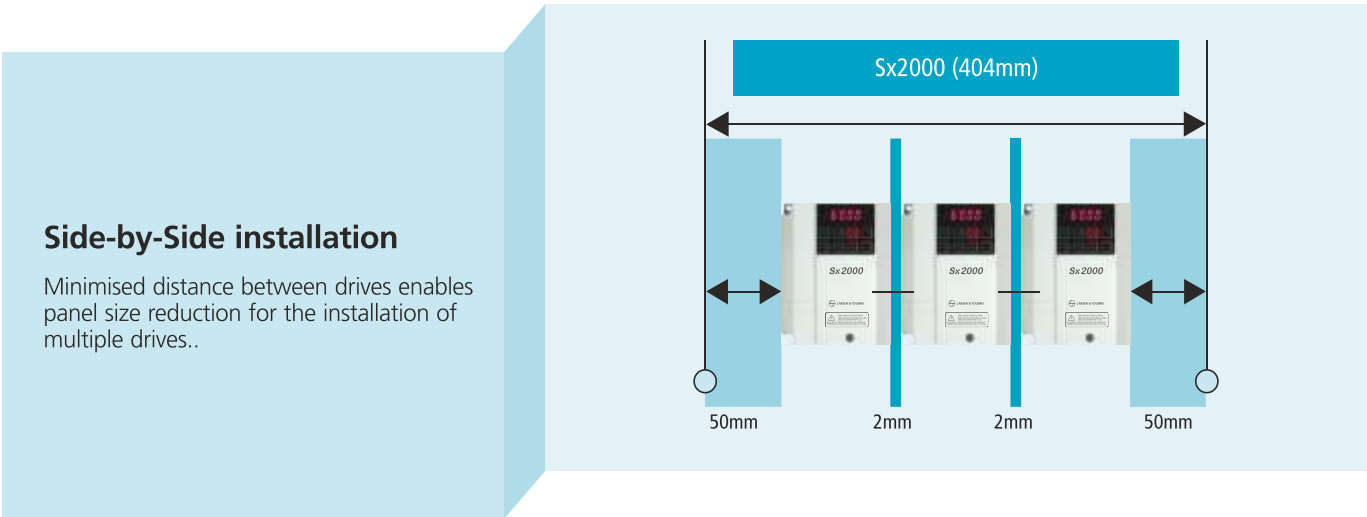

### Safety Function

Sx2000 has in-built safety functions conforming to modern safety standards.

#### Built-in Safe Torque Off (STO)

The safety input function meets EN ISO 13849-1 PLd and EN 61508 SIL2 (EN60204-1, stop category 0). This feature is standard and enables compliance with current safety standards.

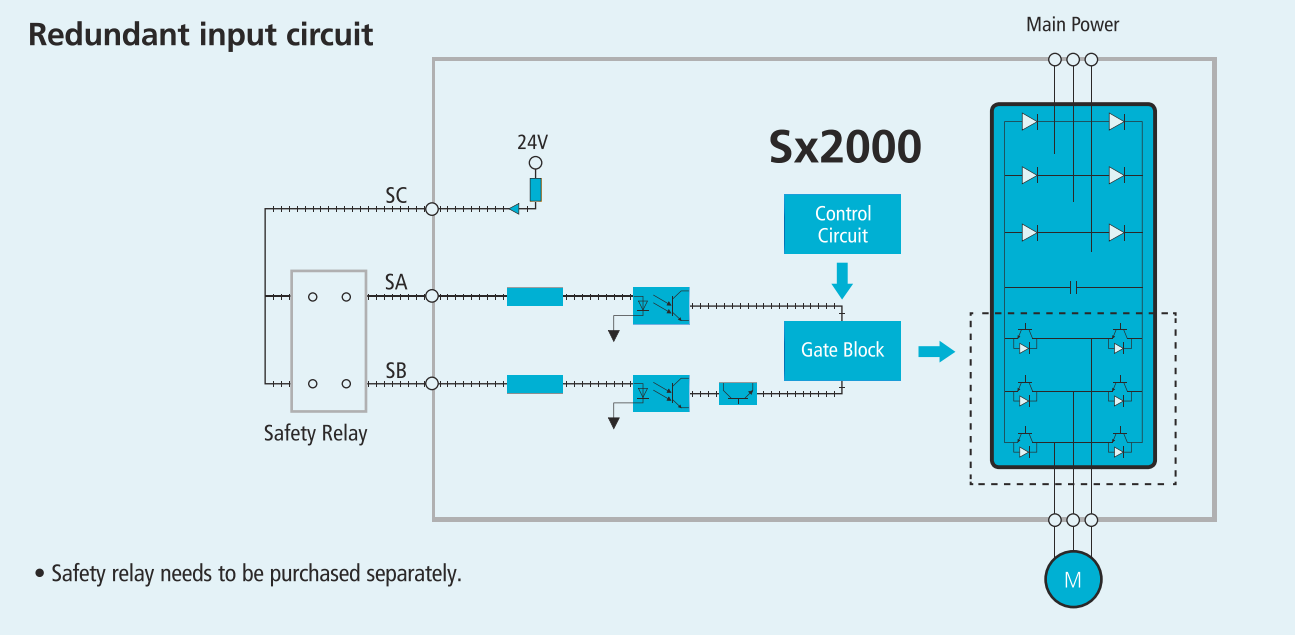

## ➤ User-Friendly

The Sx2000 offers a variety of conveniences to you.

### Various field bus options - easy to install and use.

You can connect to a variety of fieldbus networks  
Easy maintenance and mounting

- ① Profibus-DP ② Ethernet IP ③ Modbus TCP ④ CANopen



### Simple cooling fan replacement

Tool-less replacement of cooling fan without dismantling the drive



### Flange type

The heat sink can be mounted outside of the panel in case the space is limited.



### User sequence function

Simple PLC sequences can be operated with various function block combinations.

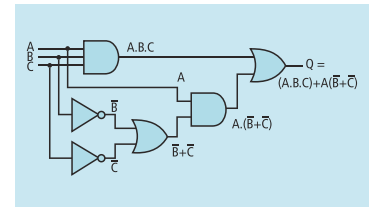

### Multi-keypad function

Single LCD keypad can be used to set up the parameters of a RS485 connected drives.

- LCD keypad (same as Fx2000 model) enables handy parameter set up.
- Multi-language support will be available.

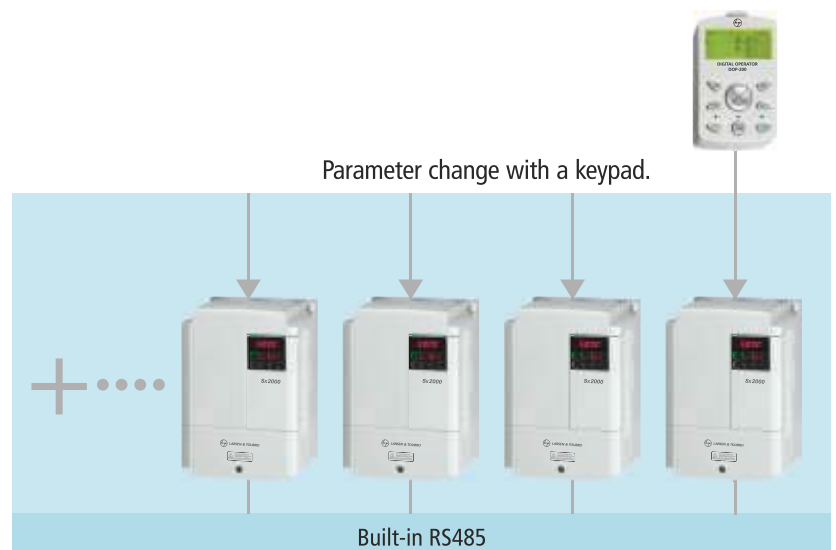

## ➤ User-Friendly

### Drive connect connection with RJ45 port

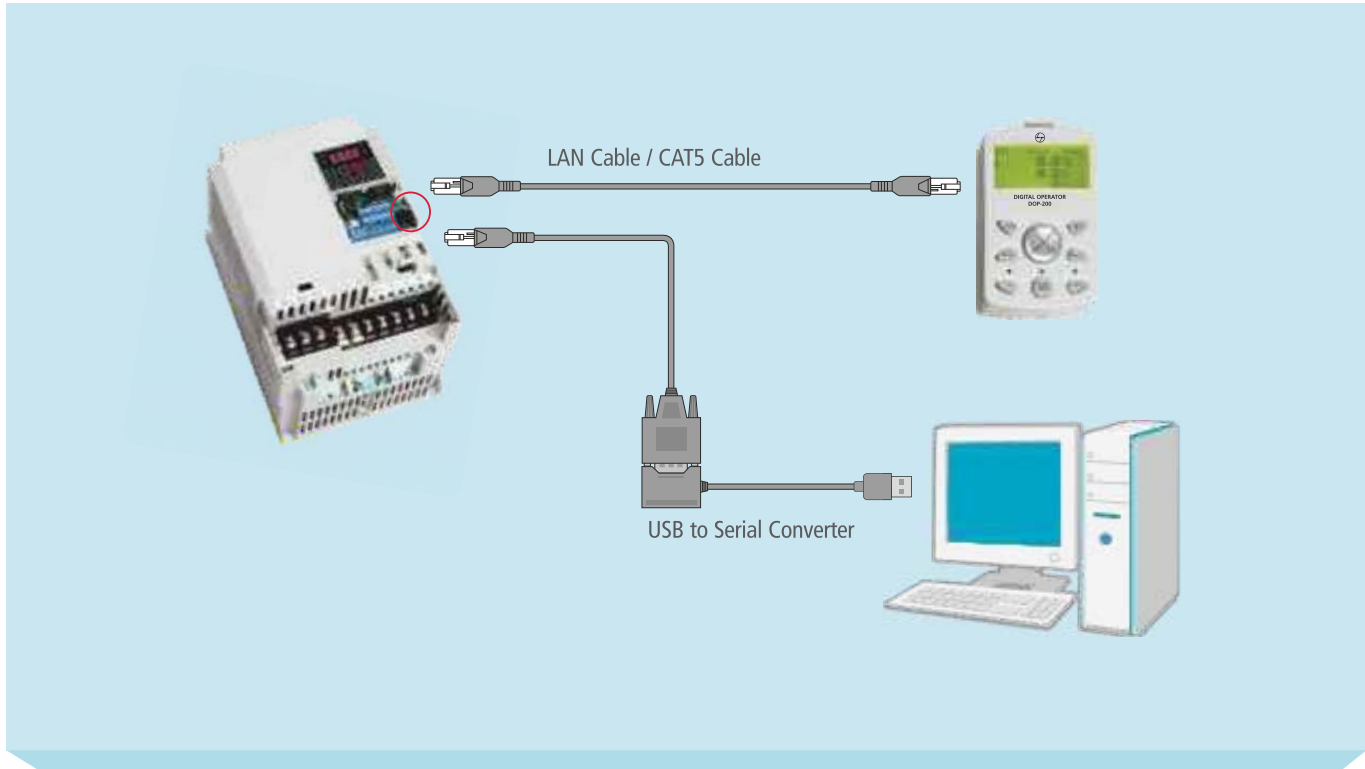

## ➤ Standard Compliance

The Sx2000 complies with a diverse range of international standards.

### Built-in DC reactor

Effective in improving power factor and decreasing THD.

- 3-phase 400V 30~75kW

### Global Compliance

Global standard compliance



### Dual rating operation

Designed to be used for heavy and normal duty applications.

- Overload capacity – Heavy duty operation: **150%** of rated current, 60 seconds  
– Normal duty operation: **120%** of rated current, 60 seconds

### Selectable Rotary/Standstill auto-tuning

Standstill / Rotary auto-tuning options are available as standard to find motor constants with or without rotating the motor for optimised motor performance.



➤ The drive **for harsh environmental** conditions.

### Sx2000 IP66 / NEMA 4X Series

Protected against foreign substances such as fine dust and high pressure water spray.

- Satisfies NEMA standard type 4X for indoor use
- 230/415V 0.4~22kW

**Available  
soon**



## Model & Type

Motor Rating (Normal Duty)	Single-Phase 230V	Three-Phase 230V		Three-Phase 415V	
	IP20	IP20	IP66	IP20	IP66
0.75 kW	LTVF-S10003BAA	LTVF-S20003BAA	LTVF-S20003XAA	LTVF-S40002BAA	LTVF-S40002XAA
1.5 kW	LTVF-S10006BAA	LTVF-S20006BAA	LTVF-S20006XAA	LTVF-S40003BAA	LTVF-S40003XAA
2.2 kW	LTVF-S10010BAA	LTVF-S20010BAA	LTVF-S20010XAA	LTVF-S40005BAA	LTVF-S40005XAA
3.7 kW	LTVF-S10012BAA	LTVF-S20012BAA	LTVF-S20012XAA	LTVF-S40007BAA	LTVF-S40007XAA
5.5 kW		LTVF-S20018BAA	LTVF-S20018XAA	LTVF-S40010BAA	LTVF-S40010XAA
7.5 kW		LTVF-S20030BAA	LTVF-S20030XAA	LTVF-S40016BAA	LTVF-S40016XAA
11 kW		LTVF-S20040BAA	LTVF-S20040XAA	LTVF-S40023BAA	LTVF-S40023XAA
15 kW		LTVF-S20056BAA	LTVF-S20056XAA	LTVF-S40030BAA	LTVF-S40030XAA
18.5 kW		LTVF-S20069BAA	LTVF-S20069XAA	LTVF-S40038BAA	LTVF-S40038XAA
22 kW				LTVF-S40044BAA	LTVF-S40044XAA
30 kW				LTVF-S40058BAA	LTVF-S40058XAA
37 kW				LTVF-S40075BAA	
45 kW				LTVF-S40091BAA	
55 kW				LTVF-S40107BAA	
75 kW				LTVF-S40142BAA	
90 kW				LTVF-S40169BAA	

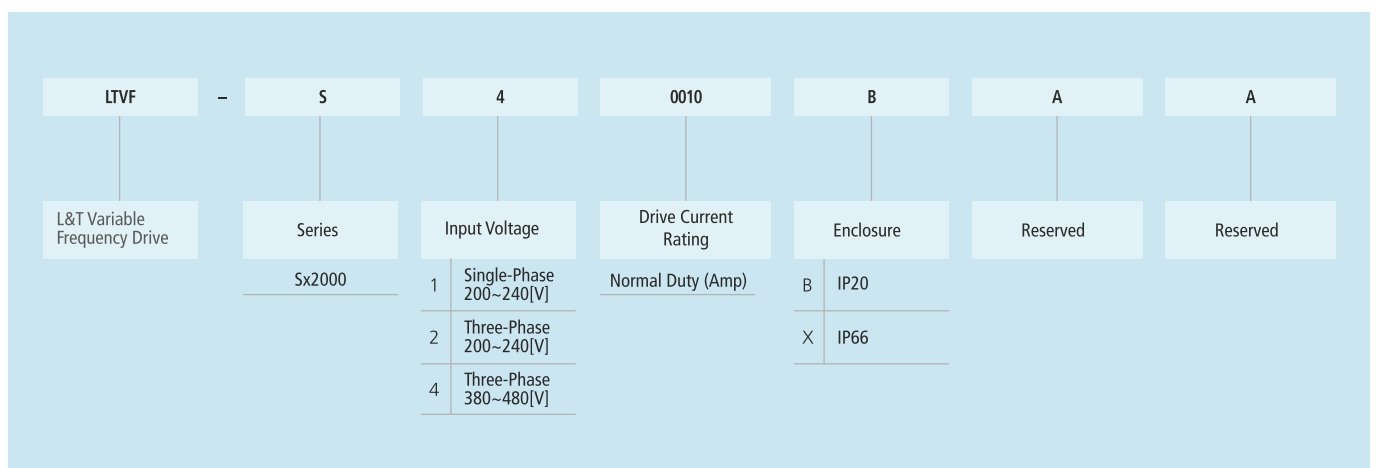

➤ **Input and output specification: Single-phase 230V (0.4 kW HD ~ 2.2 kW ND)**

LTVF-S1□□□□BAA			0003	0006	0010	0012
Motor Rating	Heavy Duty [HD]	HP	0.5	1.0	2.0	3.0
		kW	0.4	0.75	1.5	2.2
	Normal Duty [ND]	HP	1.0	2.0	3.0	5.0
		kW	0.75	1.5	2.2	3.7
Output Rating	Capacity [kVA]	Heavy Duty [HD]	1.0	1.9	3.0	4.2
		Normal Duty [ND]	1.2	2.3	3.8	4.6
	Rated Current [A]	Heavy Duty [HD]	2.5	5.0	8.0	11.0
		Normal Duty [ND]	3.1	6.0	9.6	12.0
	Frequency [Hz]	0~400Hz (IM Sensorless : 0~120[Hz])				
Voltage [V]	3-phase 200~240V					
Input Rating	Voltage [V]	1-phase 200~240VAC (-15% ~ +10%)				
	Frequency [Hz]	50~60Hz (±5%)				
	Rated Current [A]	Heavy Duty [HD]	4.4	9.3	15.6	21.7
Normal Duty [ND]		5.8	11.7	19.7	24.0	

➤ **Input and output specification: Three-phase 230V (0.4 kW HD ~ 18.5 kW ND)**

LTVF-S2□□□□BAA			0003	0006	0010	0012	0018	0030	0040	0056	0069
Motor Rating	Heavy Duty [HD]	HP	0.5	1.0	2.0	3.0	5.4	7.5	10.0	15.0	20.0
		kW	0.4	0.75	1.5	2.2	4.0	5.5	7.5	11.0	15.0
	Normal Duty [ND]	HP	1.0	2.0	3.0	5.0	7.5	10.0	15.0	20.0	25.0
		kW	0.75	1.5	2.2	3.7	5.5	7.5	11.0	15.0	18.5
Output Rating	Capacity [kVA]	Heavy Duty [HD]	1.0	1.9	3.0	4.2	6.5	9.1	12.2	17.5	22.9
		Normal Duty [ND]	1.2	2.3	3.8	4.6	6.9	11.4	15.2	21.3	26.3
	Rated Current [A]	Heavy Duty [HD]	2.5	5.0	8.0	11.0	17.0	24.0	32.0	46.0	60.0
		Normal Duty [ND]	3.1	6.0	9.6	12.0	18.0	30.0	40.0	56.0	69.0
	Frequency [Hz]	0~400Hz (IM Sensorless : 0~120[Hz])									
Voltage [V]	3-phase 200~240V										
Input Rating	Voltage [V]	3-phase 200~240VAC (-15% ~ +10%)									
	Frequency [Hz]	50~60Hz (±5%)									
	Rated Current [A]	Heavy Duty [HD]	2.2	4.9	8.4	11.8	18.5	25.8	34.9	50.8	66.7
Normal Duty [ND]		3.0	6.3	10.8	13.1	19.4	32.7	44.2	62.3	77.2	

### Input and output specification Three-phase 415V (0.4 kW HD ~ 30 kW ND)

LTVF-S4□□□□BAA			0002	0003	0005	0007	0010	0016	0023	0030	0038	0044	0058
Motor Rating	Heavy Duty [HD]	HP	0.5	1.0	2.0	3.0	5.4	7.5	10.0	15.0	20.0	25.0	30.0
		kW	0.4	0.75	1.5	2.2	4.0	5.5	7.5	11.0	15.0	18.5	22.0
	Normal Duty [ND]	HP	1.0	2.0	3.0	5.0	7.5	10.0	15.0	20.0	25.0	30.0	40.0
		kW	0.75	1.5	2.2	3.7	5.5	7.5	11.0	15.0	18.5	22.0	30.0
Output Rating	Capacity [kVA]	Heavy Duty [HD]	1.0	1.9	3.0	4.2	6.5	9.1	12.2	18.3	22.9	29.7	34.3
		Normal Duty [ND]	1.5	2.4	3.9	5.3	7.6	12.2	17.5	22.9	29.0	33.5	44.2
	Rated Current [A]	Heavy Duty [HD]	1.3	2.5	4.0	5.5	9.0	12.0	16.0	24.0	30.0	39.0	45.0
		Normal Duty [ND]	2.0	3.1	5.1	6.9	10.0	16.0	23.0	30.0	38.0	44.0	58.0
	Frequency [Hz]	0~400Hz (IM Sensorless : 0~120[Hz])											
Voltage [V]	3-phase 380~480V												
Input Rating	Voltage [V]	3-phase 380~480VAC (-15% ~ +10%)											
	Frequency [Hz]	50~60Hz (±5%)											
	Rated Current [A]	Heavy Duty [HD]	1.1	2.4	4.2	5.9	9.8	12.9	17.5	26.5	33.4	43.6	50.7
Normal Duty [ND]		2.0	3.3	5.5	7.5	10.8	17.5	25.4	33.4	42.5	49.5	65.7	
DC Reactor			External [option]										
Display			LED [LCD optional]										
Braking Unit			Built-in										

### Input and output specification: Three-phase 415V (30 kW HD ~ 90 kW ND)

LTVF-S4□□□□BAA			0075	0091	0107	0142	0169
Motor Rating	Heavy Duty (HD)	HP	40.0	50.0	60.0	75.0	100.0
		kW	30.0	37.0	45.0	55.0	75.0
	Normal Duty (ND)	HP	50.0	60.0	75.0	100.0	120.0
		kW	37.0	45.0	55.0	75.0	90.0
Output Rating	Capacity [kVA]	Heavy Duty [HD]	46.5	57.2	69.4	83.8	115.8
		Normal Duty [ND]	57.2	69.4	81.5	108.2	128.8
	Rated Current	Heavy Duty [HD]	61.0	75.0	91.0	110.0	152.0
		Normal Duty [ND]	75.0	91.0	107.0	142.0	169.0
	Frequency [Hz]	0~400Hz (IM Sensorless : 0~120[Hz])					
Voltage [V]	3-phase 380~480V						
Input Rating	Voltage [V]	3-phase 380~480VAC (-15% ~ +10%)					
	Frequency [Hz]	50~60Hz (±5%)					
	Rated Current [A]	Heavy Duty [HD]	56.0	69.0	85.0	103.0	143.0
Normal Duty [ND]		69.0	85.0	100.0	134.0	160.0	
DC Reactor			Built-in				
Display			LCD				
Braking Unit			External [option]				

## Control

Control Method	V/f Slip compensation, Sensorless vector
Frequency Setting Resolution	Digital command: 0.01Hz / Analog command: 0.05Hz (maximum frequency: 50Hz)
Frequency Accuracy	1% of the maximum output frequency
V/F Pattern	Linear, Squared, User V/F
Overload Capacity	HD: 150% 1 minute, ND: 120% 1 minute
Torque Boost	Manual/Automatic torque boost

## Operation

Operation Mode	Keypad / Terminal / Communication option selectable		
Frequency Setting	Analog : -10~10[V], 0~10[V], 4~20[mA] / Digital : Keypad, Pulse train input		
Operation Function	PID control, 3-wire operation, frequency limit, second function, anti-forward and reverse direction rotation, commercial transition, speed search, power braking, leakage reduction, up-down operation, DC braking, frequency jump, slip compensation, automatic restart, automatic tuning, energy buffering, flux braking, fire mode		
Input	Multi-function Terminal 7 points	NPN (Sink) / PNP (Source) Selectable Function: Forward run, reverse run, reset, external trip, emergency stop, jog operation, multi-step frequency-high, middle, low, multi-step acceleration/ deceleration-high, middle, low, DC braking at stop, 2nd motor select, frequency up/down, 3-wire operation, change into normal operation during PID operation, Local/Remote operation mode, analog command frequency fixing, acceleration/deceleration stop etc. selectable.	
	Analog Input	V1:- 10~10V V2:- 0~10V/4~20mA Selectable	
	Pulse Train	0Hz~32kHz, Low level: 0~0.8V, High level: 3.5~12V	
Output	Open Collector Terminal	0.4kW to 22kW:- 1 Relay & 1 Open Collector output	less than DC 24V 50mA
	Multi-function Relay	30kW to 75kW:- 2 Relay & 1 Open Collector output	(N.O., N.C.) less than AC 250V 1A, less than DC 30V 1A
	Analog Output	0~10V/4~20mA Selectable [0.4kW to 22kW:- 1 No., 30kW to 75kW:- 2 Nos.]	
	Pulse Train	Maximum 32kHz, 10~12 [V]	

## Protective Function

Trip	Over-current trip, external signal trip, ARM short circuit current trip, overheat trip, Input imaging trip, ground trip, motor over heat trip, I/O board link trip, No motor trip, parameter writing trip, emergency stop trip, command loss trip, external memory error, CPU watchdog trip, motor normal load trip, over voltage trip, temperature sensor trip, drive overheat, option trip, output imaging trip, drive overload trip, fan trip, pre-PID operation failure, external break trip, low voltage trip during operation, low voltage trip, safety A(B) trip, analog input error, motor overload trip,
Alarm	Command loss trip alarm, overload alarm, normal load alarm, drive overload alarm, fan operation alarm, resistance braking rate alarm, number of corrections on rotor tuning error
Momentary Power Loss	HD below 15ms (ND below 8ms): Continuous operation (To be within rated input voltage, rated output) HD above 15ms (ND above 8ms): Automatic restart operation enable

## Environment

Cooling Type	Forced fan cooling structure Forced cooling type : 0.8-15 kW 230V/1.5-75 kW 415V
Protection Degree	IP20/UL Open (Default), UL Enclosed Type 1 (Option), IP66/NEMA 4X (Option)
Ambient Temperature	Ambient temperature under the condition of no ice or frost. HD: -10~50°C / ND: -10~40°C [However, recommended to use load below 80% when using at 50°C under Normal Duty]
Storage Temperature	-20 ~ 65 degrees C
Humidity	Relative humidity below 90% RH (no dew formation)
Altitude, Vibration	Below 1,000m, below 5.9m/sec <sup>2</sup> (0.6G)
Location	No corrosive gas, flammable gas, oil mist etc. indoors (pollution degree 2 environment)
Pressure	70~106 kPa

## Power Terminal Specifications

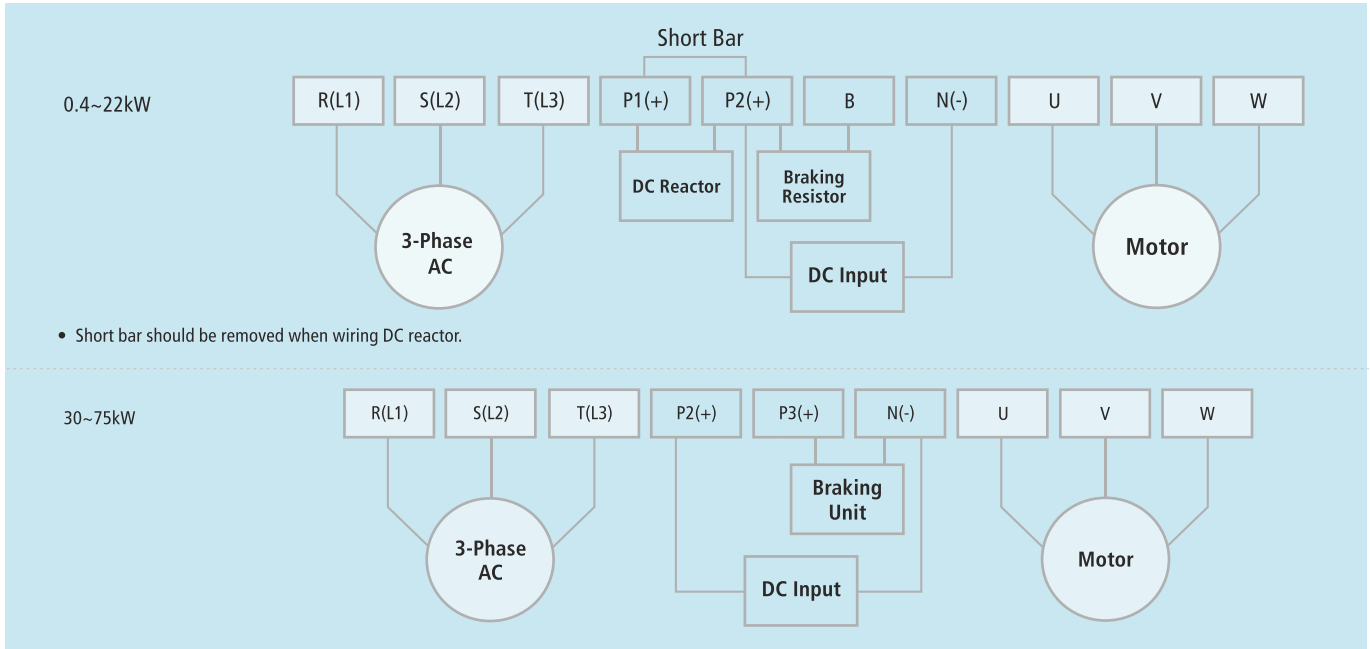

Drive Cat. No.		Screw	1) Torque Kgf • cm	2) Wire			
				mm2		AWG	
				R.S.T	U.VW	R.S.T	U.VW
230V Single Phase	LTVF-S10003BAA	M3.5	2.1 ~ 6.1	2	2	14	14
	LTVF-S10006BAA	M3.5	2.1 ~ 6.1	2	2	14	14
	LTVF-S10010BAA	M3.5	2.1 ~ 6.1	2	2	14	14
	LTVF-S10012BAA	M4	2.1 ~ 6.1	3.5	3.5	12	12
230V Three Phase	LTVF-S20003BAA	M3.5	2.1 ~ 6.1	2	2	14	14
	LTVF-S20006BAA	M3.5	2.1 ~ 6.1	2	2	14	14
	LTVF-S20010BAA	M3.5	2.1 ~ 6.1	2	2	14	14
	LTVF-S20012BAA	M4	2.1 ~ 6.1	3.5	3.5	12	12
	LTVF-S20018BAA	M4	2.1 ~ 6.1	3.5	3.5	12	12
	LTVF-S20030BAA	M4	2.1 ~ 6.1	6	6	10	10
	LTVF-S20040BAA	M4	2.1 ~ 6.1	6	6	10	10
	LTVF-S20056BAA	M5	4.0 ~ 10.2	10	10	8	8
LTVF-S20069BAA	M5	4.0 ~ 10.2	16	16	6	6	
415V Three Phase	LTVF-S40002BAA	M3.5	2.1 ~ 6.1	2	2	14	14
	LTVF-S40003BAA	M3.5	2.1 ~ 6.1	2	2	14	14
	LTVF-S40005BAA	M3.5	2.1 ~ 6.1	2	2	14	14
	LTVF-S40007BAA	M3.5	2.1 ~ 6.1	2	2	14	14
	LTVF-S40010BAA	M4	2.1 ~ 6.1	2	2	14	14
	LTVF-S40016BAA	M4	2.1 ~ 6.1	2.5	2.5	14	14
	LTVF-S40023BAA	M4	2.1 ~ 6.1	4	4	12	12
	LTVF-S40030BAA	M5	4.0 ~ 10.2	4	4	12	12
	LTVF-S40038BAA	M5	4.0 ~ 10.2	6	6	10	10
	LTVF-S40044BAA	M5	4.0 ~ 10.2	10	10	8	8
	LTVF-S40058BAA	M5	4.0 ~ 10.2	16	10	8	8
	LTVF-S40075BAA	M8	61.2 ~ 91.8	25	25	4	4
	LTVF-S40091BAA	M8	61.2 ~ 91.8	25	25	4	4
	LTVF-S40107BAA	M8	61.2 ~ 91.8	70	70	1/0	1/0
	LTVF-S40142BAA	M8	61.2 ~ 91.8	70	70	1/0	1/0
	LTVF-S40169BAA	M8	61.2 ~ 91.8	70	70	1/0	1/0

<sup>1)</sup> Only use the specified torque on the screw heads, otherwise damage could occur. Loose screws can cause overheating and damage.

<sup>2)</sup> Use copper wires with 600V, 90°C specification.

Standard Connection Diagram [0.4~22kW]

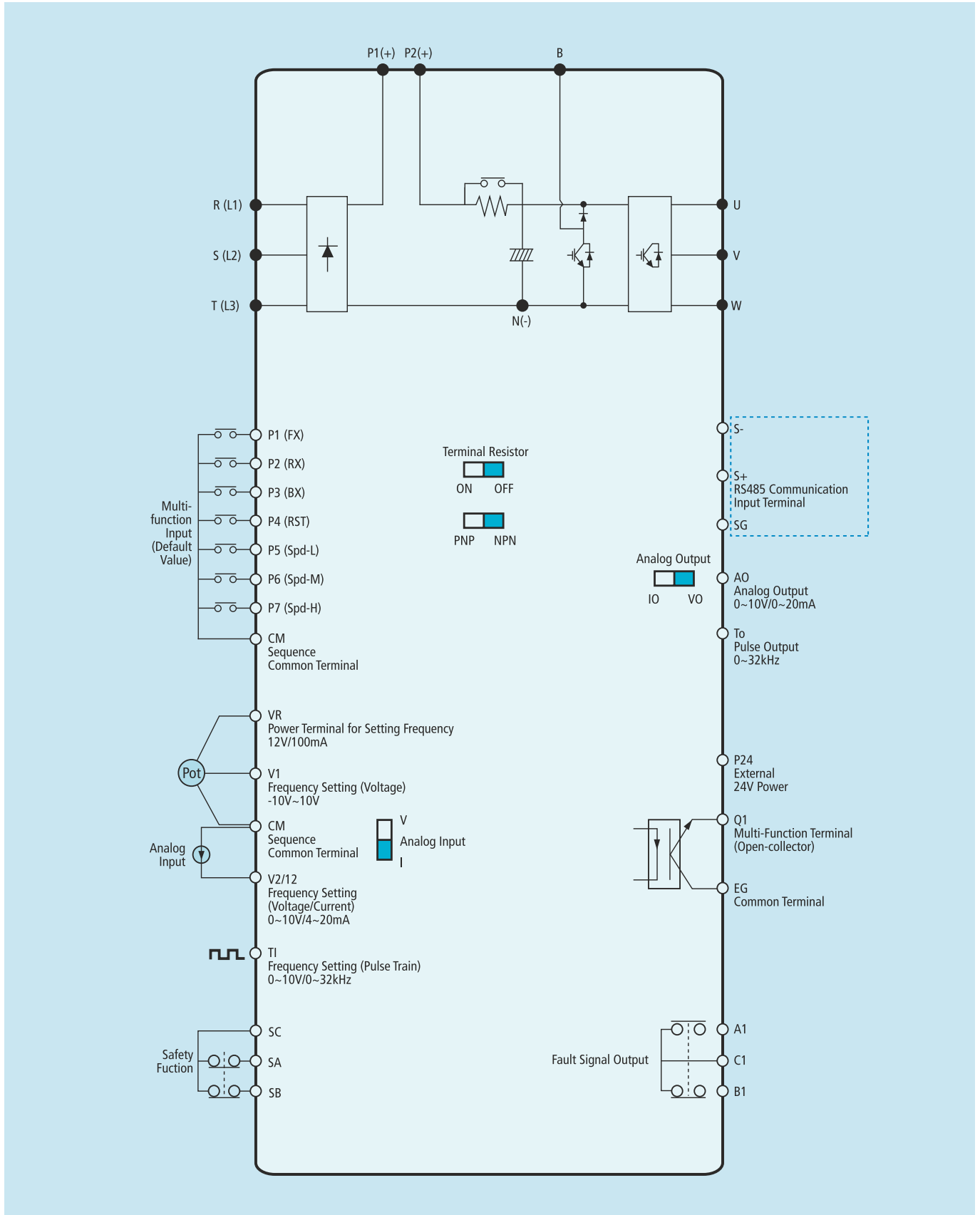

Standard Connection Diagram [30~75kW]

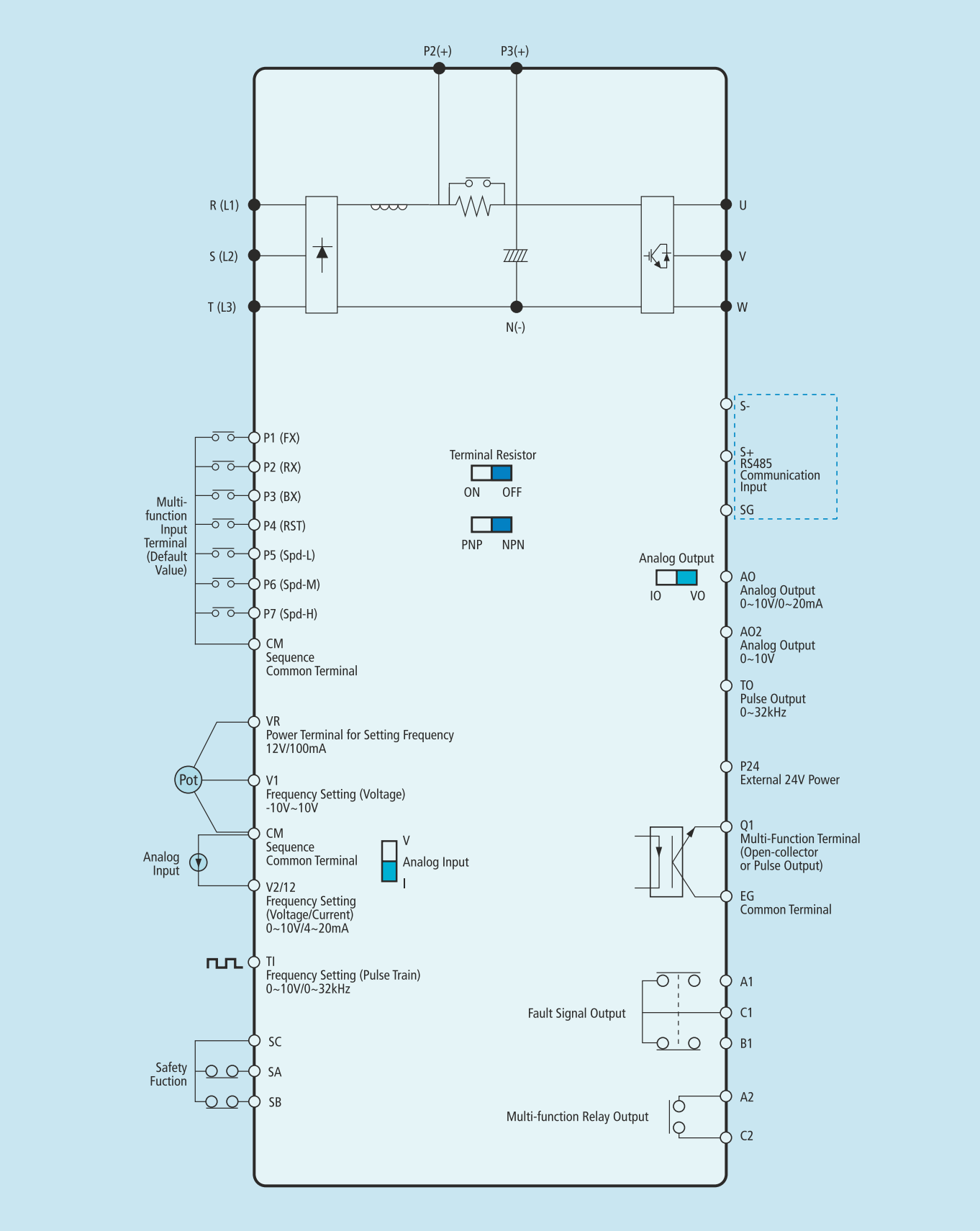

## Control Terminal Configuration

### 0.4~22kW

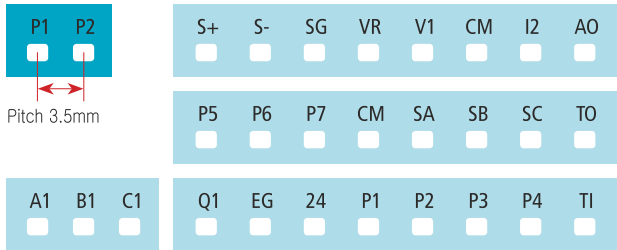

### 30~75kW



• I/O board is supplied built-in the Sx2000 LCD loader, and can be mounted on the front of the drive. • NC : Terminal not in use.

Terminal Type	Electrical Specifications	Recommended Wire Size [mm <sup>2</sup> ] (AWG)		Screw	Torque
		No Crimp-style Terminal	Crimp-style Terminal		N.m
P1~P7, CM		0.75 (18)	0.5 (20)	M2	0.22 ~ 0.25
VR	Max output V/I : 12V, 100mA, volume resistor 1~5kΩ				
V1	UNIPOLAR : 0 ~ 10V (max 12V) BIPOLAR : -10 ~ 10V (max ±12V)				
I2	4~20mA(max 0~24mA, input resistor 249Ω)				
AO1	0 ~ 10V (max output V/I : 12V, 10mA) 0 ~ 20mA (Load resistor less than 500 Ω, max output current : 24mA)				
AO2	0 ~ 10V (max output V/I : 12V, 10mA)				
Q1	Less than DC 26V, 100mA				
EG					
24	Max output current : 150mA				
TI	0 ~ 32kHz (Low Level : 0 ~ 0.8V High Level : 3.5 ~ 12V)				
TO	0 ~ 32kHz, 0 ~ 12V				
SA, SB, SC <sup>1)</sup>	Less than DC 24V, 25mA				
S+, S-, SG					
A1, B1, C1	Less than AC250V 1A, less than DC30V 1A	1.0(17)	1.5(15)	M2.6	0.4
A2, C2	Less than AC250V 5A, less than DC30V 5A				

<sup>1)</sup> The wire length of the safety input should not exceed 30m.

## Keypad Details

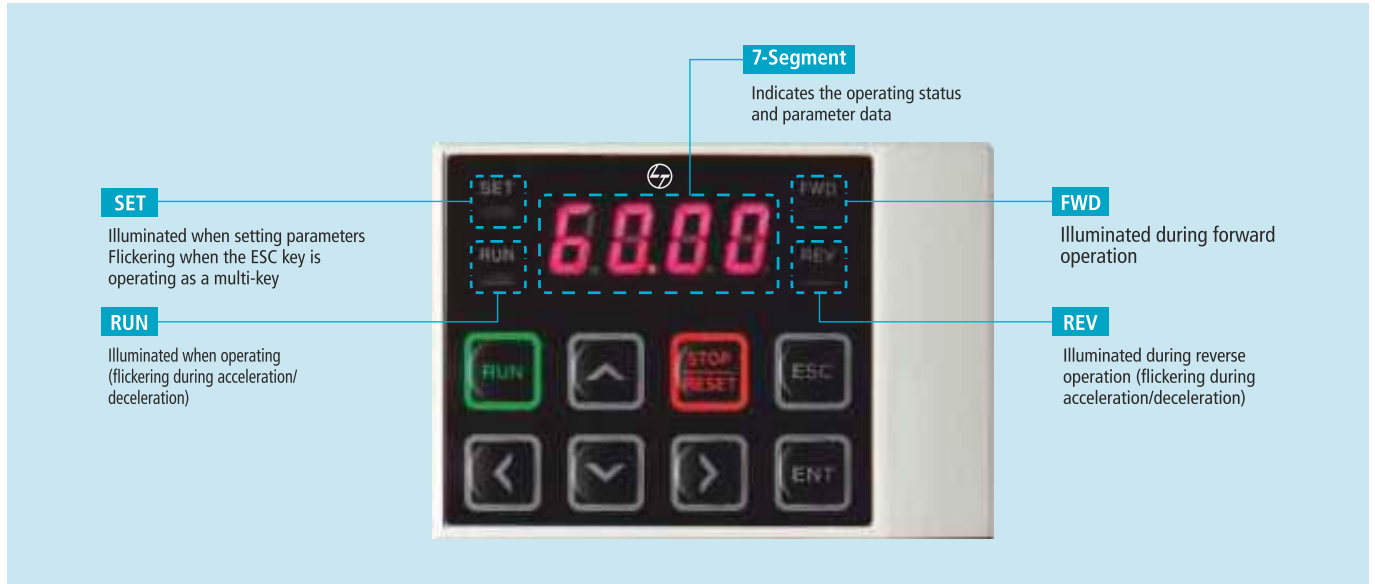

Display	Term	Function Description
	RUN Key	Run command
	STOP/RESET	STOP: Stop command during operation, RESET Reset command when a fault occurs.
	UP Key	Used to scroll through codes or to increase a parameter value
	DOWN Key	Used to scroll through codes or to decrease a parameter value
	Left Key	Used to jump to other parameter groups or move the cursor to the left
	Right Key	Used to jump to other parameter groups or move the cursor to the right
	Enter Key	Used to set a parameter value or to save the changed parameter value
	Escape Key	Used to cancel the jog or remote/local change key or when editing
FWD	Forward Run	Illuminated during forward run
REV	Reverse Run	Illuminated during reverse run
RUN	RUN Key	Illuminated during operation (flickering during acceleration/deceleration)
SET	Setting	Illuminated during parameter setting/Flickering when the ESC key is operating as a multi-key
7-Segment	Current Value	Indicates operating conditions and parameter data

Flickering when a fault occurs

## Braking Resistors

Drive Cat. No	415V Three-Phase		
	Braking Unit	Resistor [ohm]	Watt [W]
LTVF-S40002BAA	Built-in	1,200	100
LTVF-S40003BAA	Built-in	600	150
LTVF-S40005BAA	Built-in	300	300
LTVF-S40007BAA	Built-in	200	400
LTVF-S40010BAA	Built-in	130	600
LTVF-S40016BAA	Built-in	85	1,000
LTVF-S40023BAA	Built-in	60	1,200
LTVF-S40030BAA	Built-in	40	2,000
LTVF-S40038BAA	Built-in	30	2,400
LTVF-S40044BAA	Built-in	20	3,600
LTVF-S40058BAA	Built-in	20	3,600
LTVF-S40075BAA	LTDBU-0370	16.9	6,400
LTVF-S40091BAA	LTDBU-0370	16.9	6,400
LTVF-S40107BAA	LTDBU-0550	11.4	9,600
LTVF-S40142BAA	LTDBU-0550	11.4	9,600
LTVF-S40169BAA	LTDBU-0750	8.4	12,800

Note : Values of DBU-DBR are based on following considerations,  
 Drives with inbuilt DBU :Braking torque = 150% max, Enable Duty ( % ED ) = 5%. In case 10% ED DBR wattage should be double  
 Drives with external DBU, average braking torque will be 100% max with 10 % ED

## MCCB (Moulded Case Circuit Breaker) and MC (Magnetic Contactor)

Drive Cat. No.	MCCB (L&T)	MC Amp (L&T)
LTVF-S10003BAA	DM16/5	MNX 9-2P
LTVF-S10006BAA	DM16/10	MNX 12-2P
LTVF-S10010BAA	DM16/16	MNX 18-2P
LTVF-S10012BAA	DM100/25	MNX 22-2P
LTVF-S20003BAA	DM16/5	MO 9
LTVF-S20006BAA	DM16/10	MO 12
LTVF-S20010BAA	DM16/16	MO 18
LTVF-S20012BAA	DM100/25	MO 25
LTVF-S20018BAA	DM100/35	MO 32
LTVF-S20030BAA	DM100/50	MO 60
LTVF-S20040BAA	DM100/70	MO 70
LTVF-S20056BAA	DN2-250M/100	MO 95
LTVF-S20069BAA	DN2-250M/125	MNX 140

Drive Cat. No.	MCCB (L&T)	MC Amp (L&T)
LTVF-S40002BAA	DM16/2.5	MO 9
LTVF-S40003BAA	DM16/5	MO 9
LTVF-S40005BAA	DM16/10	MO 9
LTVF-S40007BAA	DM16/12	MO 12
LTVF-S40010BAA	DM100/25	MO 18
LTVF-S40016BAA	DM100/30	MO 25
LTVF-S40023BAA	DM100/35	MO 32
LTVF-S40030BAA	DM100/60	MO 50
LTVF-S40038BAA	DM100/70	MO 70
LTVF-S40044BAA	DM100/80	MO 80
LTVF-S40058BAA	DN2-250M/ 100	MO 95
LTVF-S40075BAA	DN2-250M / 125	MO 95
LTVF-S40091BAA	DN2-250M / 160	MNX 140
LTVF-S40107BAA	DN2-250M / 160	MNX 140
LTVF-S40142BAA	DN2-250M / 200	MNX 185
LTVF-S40169BAA	DN3-400M / 320	MNX 225

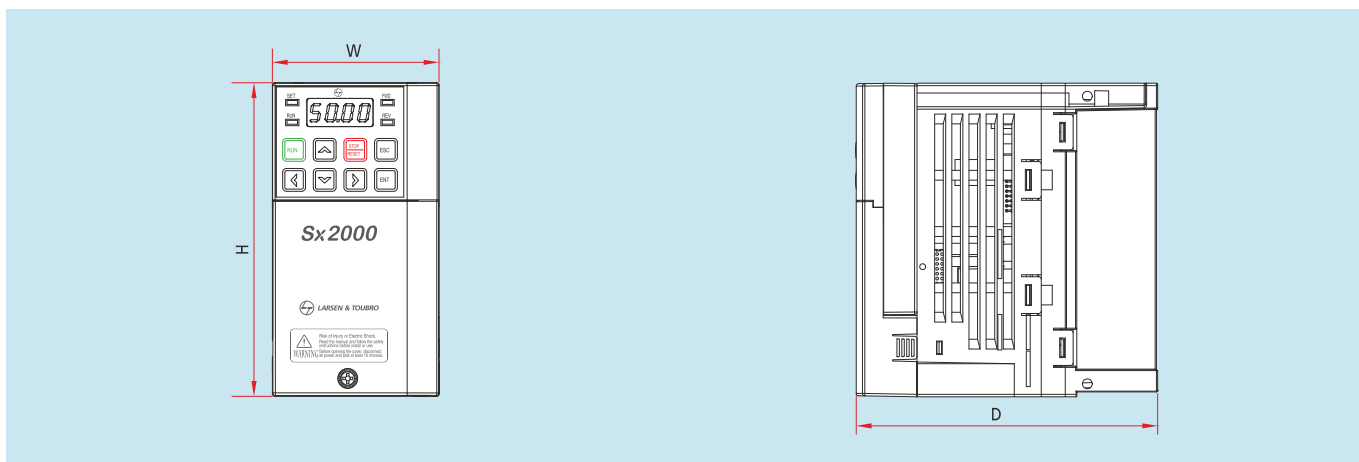

Input Voltage	Drive Cat. No.	W (mm)	H (mm)	D (mm)	Weight (kg)
Single Phase 230 V	LTVF-S10003BAA	68	128	128	0.88
	LTVF-S20003BAA	68	128	123	0.86
Three Phase 230 V	LTVF-S20006BAA	68	128	128	0.86
	LTVF-S40002BAA	68	128	123	0.86
Three Phase 415 V	LTVF-S40003BAA	68	128	128	0.88

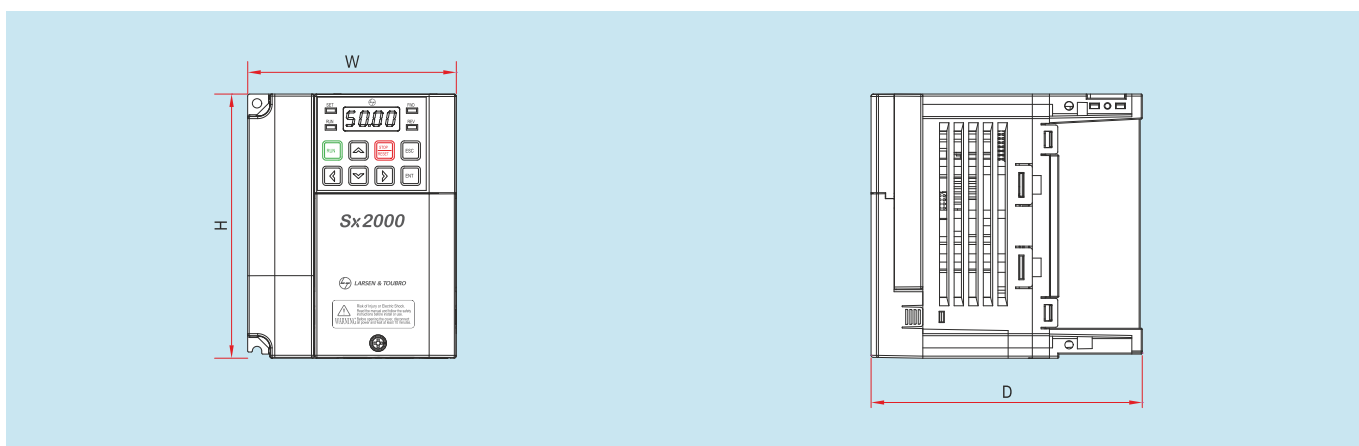

Input Voltage	Drive Cat. No.	W (mm)	H (mm)	D (mm)	Weight (kg)
Single-Phase 230 V	LTVF-S10006BAA	100	128	130	1.3
	LTVF-S10010BAA	100	128	145	1.5
	LTVF-S10012BAA	140	128	145	2.2
Three-Phase 230 V	LTVF-S20010BAA	100	128	130	1.5
	LTVF-S20012BAA	100	128	145	1.5
	LTVF-S20018BAA	140	128	145	2.3
Three-Phase 415 V	LTVF-S40005BAA	100	128	130	1.5
	LTVF-S40007BAA	100	128	145	1.5
	LTVF-S40010BAA	140	128	145	2.7

Note: The above images are solely for reference purposes. Please refer to the technical manual.

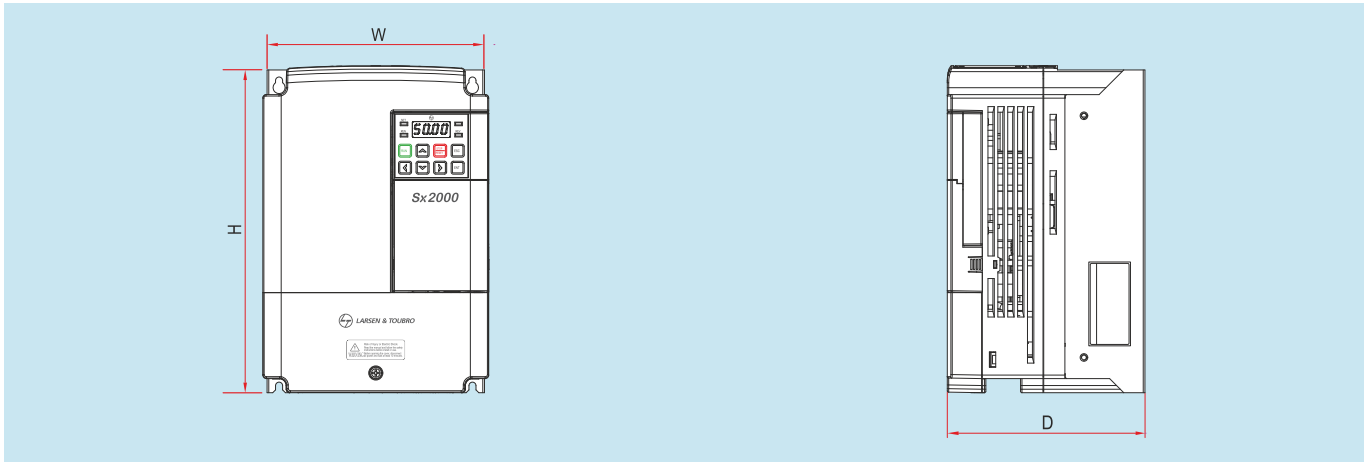

Input Voltage	Drive Cat. No.	W (mm)	H (mm)	D (mm)	Weight (kg)
Three-Phase 230 V	LTVF-S20030BAA	160	232	140	3.3
	LTVF-S20040BAA	160	232	140	3.3
	LTVF-S20056BAA	180	290	163	4.6
	LTVF-S20069BAA	220	350	187	4.6
Three-Phase 415 V	LTVF-S40016BAA	160	232	140	3.3
	LTVF-S40023BAA	160	232	140	3.4
	LTVF-S40030BAA	180	290	163	4.6
	LTVF-S40038BAA	180	290	163	4.8
	LTVF-S40044BAA	220	350	187	7.5
	LTVF-S40058BAA	220	350	187	7.5

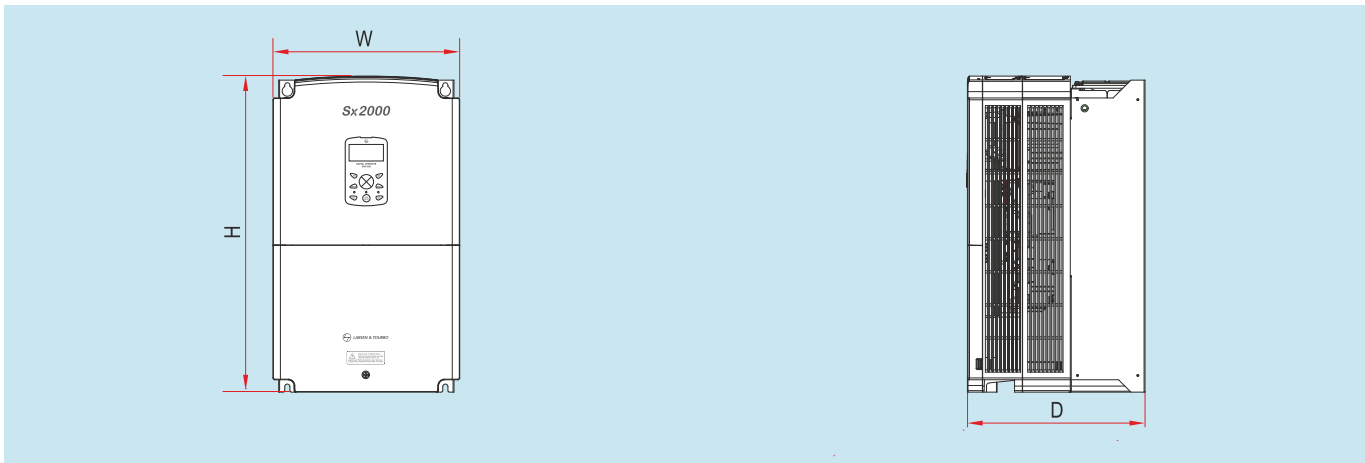

Input Voltage	Drive Cat. No.	W (mm)	H (mm)	D (mm)	Weight (kg)
Three Phase 415 V	LTVF-S40075BAA	275	450	284	26
	LTVF-S40091BAA	325	510	284	35
	LTVF-S40107BAA	325	510	284	35
	LTVF-S40142BAA	325	550	309	43
	LTVF-S40169BAA	325	550	309	43

Note: The above images are solely for reference purposes. Please refer to the technical manual.

